



# **GENERAL**

**TRUCK PARTS  
& EQUIPMENT**

Distributor/Partner Program Overview

MAKE ONE CALL. WE STOCK IT ALL!



800-621-3914

[www.generaltruckparts.com](http://www.generaltruckparts.com)

CORPORATE HEADQUARTERS

4040 W. 40th Street, Chicago, IL 60632

[info@generaltruckparts.com](mailto:info@generaltruckparts.com)



# GENERAL TRUCK PARTS & EQUIPMENT

**MAKE ONE CALL. WE STOCK IT ALL!**

## North America's authority on all things heavy-duty driveline related!

General Truck Parts and Equipment is a supplier of new and re-manufactured drive train components that include manual and automatic transmissions, differentials, transfer cases, steering gears and many other related components for both on highway and off highway applications. We have an extensive inventory on hand and ready to ship out of eight distribution centers located throughout the country. General Truck Parts and Equipment has been a leader in the truck parts industry for fifty years. Call us today to find out why.

**AXLETECH**

**TREMEC**

Authorized

**SPICER**



Off-Highway Service Center



**MERITOR**

Authorized Rebuilder

*Fabco*  
R.CUSHMAN



Marmon-Herrington

**SISU AXLES**



**CHICAGO • DALLAS • DENVER • INDIANAPOLIS • KANSAS CITY  
MINNEAPOLIS • NASHVILLE • PORTLAND • ROCHESTER**

**800-621-3914**

[www.generaltruckparts.com](http://www.generaltruckparts.com)

**CORPORATE HEADQUARTERS**

4040 W. 40th Street, Chicago, IL 60632

[info@generaltruckparts.com](mailto:info@generaltruckparts.com)



## PRODUCT KNOWLEDGE & EXPERTISE

Since 1970, General Truck Parts™ (GTP) is your source for new and re-manufactured truck parts. We serve the truck parts and equipment industry for on and off highway, industrial, agricultural, construction, mining, logging, light, medium and heavy duty trucks. Our dedicated staff is committed to providing outstanding product knowledge, excellent customer service and solutions that fit any budget!

### Transmission & Transfer Case Parts & Assemblies

General Truck Parts (GTP) is one of the nation's largest suppliers and re-manufactured and new transmissions, transfer cases and parts. Our extensive inventory includes current as well as older/hard-to-find on and off highway models for light, medium and heavy-duty use. New transmissions and transfer cases are available for upgrade and new applications. All of our transmissions are tested on our state-of-the-art dynamometer to ensure a problem-free operation. With over 50-years of experience, we have the products and expertise to get you back up and running.

**Please contact us to find out about our competitive pricing and same-day shipping!**

**We also stock thousands of auxiliary transmissions and other hard-to-find parts.**

### Differential Parts & Assemblies

GTP knows differentials inside and out. We stock thousands of new and re-manufactured differentials for on highway, off highway, industrial, agricultural, construction, mining, logging, light and heavy-duty trucks and equipment.

**We are your supplier of truck parts/remanufacturing needs, with competitive pricing and top-of-the-line service!**

### Off Highway Experts

GTP supplies new and re-manufactured differentials, transmissions, axle assemblies, transfer cases and complete inventory of service parts, for many off-highway applications.

Our Spicer and Kessler technicians have been factory trained and certified.

### Pumps, Drives, PTO's, Power Steering & Hydraulics

We supply hydraulic pumps/motors, PTO's (power take-offs), power steering gear boxes and pumps. Whether specifying new mobile power systems, rebuilding pumps or PTO's, we service practically any mobile power requirement or power steering component.

As a Muncie Master Warehouse Distributor®, we feature an extensive inventory of Muncie Power Products® and rebuilt PTO's. We also stock over 500 power steering gears and pumps ready for immediate exchange including our own re-manufactured and factory re-manufactures gears and pumps.

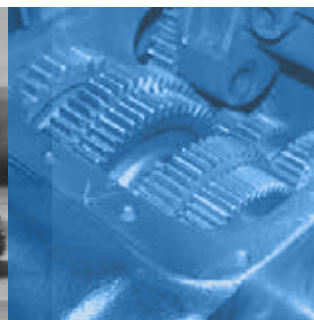
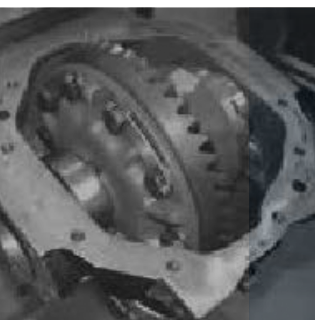

## TRANSMISSIONS

General Truck Parts and Equipment is a supplier of manual and automatic transmissions and transfer case products, both remanufactured and new. We test all remanufactured transmissions on our state-the-art dynamometer. Our technicians are some of the best in the industry.



## STEERING GEAR

General Truck Parts and Equipment is an authorized supplier and remanufacturer of steering gears. Our quality is second to none. We test all remanufactured steering gears.



## DIFFERENTIALS

General Truck Parts and Equipment is the differential expert for on-highway, off-highway, industrial, agricultural, construction, mining and logging heavy duty trucks and equipment. General Truck Parts and Equipment also carries light and medium duty differentials and parts.



### 3 YEAR WARRANTY

MANUAL & AUTOMATIC TRANSMISSIONS

DIFFERENTIALS

**OVER 7,000 NEW OR REBUILT UNITS IN STOCK & READY TO SHIP**

\*ALLISON UNITS ARE REBUILT \*\* 1 YEAR WARRANTY ON THE I-SHIFT AND M-DRIVE TRANSMISSIONS



# Preferred Manufacturers



## TRANSMISSION & TRANSFER CASES

Allison®	Dresser®	GMC®	New Process®	TTC®
Axeletech®	Eaton®	IHC®	New Venture®	Twin Disc®
Borg Warner®	Fabco®	Mack®	Noster®	ZF®
Clark®	Fuller®	Meritor®	Rockwell®	
Cushman®	Funk®	Navistar®	Spicer®	

## DIFFERENTIAL PARTS & ASSEMBLIES

Axeletech®	Fabco®	Mack®	Navistar®	Spicer®
Clark Dana®	GMC®	Marmon®	Oshkosh®	ZF®
Eaton®	IHC®	Meritor®	Rockwell®	

## OFF-HIGHWAY EXPERTS & AUTHORIZED SPICER® SERVICE CENTER

AG-Chem®	Genie®	Koehring®	Lundy®	Terex®
Badger®	Gradall®	Komatsu®	P&H®	Tracmobile®
Blount®	Grove®	LimaLink Belt®	Pettibone®	
Euclid®	Kessler®	Lull®	Taylor®	

## AUTHORIZED SPICER® OFF-HIGHWAY SERVICE CENTER SERVICING:

Spicer®	Kirkstall®	Clark-Hurth®	Sige®	Comaxle®
---------	------------	--------------	-------	----------

## PUMPS, DRIVES, PTOS, POWER STEERING & HYDRAULICS

### PRODUCTS:

PTOs	Manual & Power Steering Gear Boxes
Hydraulic Pumps & Motors	Steering Cylinders
Power Steering Pumps	Lift Cylinders (up to 5 stage)

### BRANDS:

Apsco®	Gates®	Rexroth®	TRW®
Chelsea®	Gemmer®	RH Shepard®	Tyrone®
Custom Hoists, Inc.®	Muncie®	Ross®	Vickers®
Eaton®	Permco®	Saginaw®	ZF®



MAKE ONE CALL.  
WE STOCK IT ALL!



# Allison Transmission

General Truck Part and Equipment is a factory authorized Allison dealer in our Apple Valley, MN location. All of our technicians have been factory trained and certified by Allison. All of our rebuilt Allison Transmissions carry a 36 month, unlimited mileage, nationwide warranty. Parts and labor included.

**For pricing and availability inquires or technical support, contact:**  
**Bob Kovacs at 800-621-3914 or email at [bobk@generaltruckparts.com](mailto:bobk@generaltruckparts.com)**



**MERITOR**

Authorized Rebuilder

# Meritor

100% genuine Meritor components. Re-manufactured to the latest factory design level by factory trained and certified technicians using the latest, factory authorized state of the art processes. 24 hour guaranteed shipping throughout our distribution network and factory supported 24 month nationwide warranty. Available in 14X, 40-145 and 46-160 models. All ratios and all configurations.



# Kessler+Co

General Truck Part and Equipment is a factory authorized Kessler + Co dealer. All of our technicians have been factory trained and certified by Kessler + Co. Call General Truck Part and Equipment for all your Kessler + Co axel and gearbox needs.



# Warehouse Locations



Getting you the heavy-duty truck part you need, faster.

## 1-DAY SERVICE TO 44 STATES!

FROM OUR DISTRIBUTION CENTERS:

CHICAGO, IL

DALLAS, TX

DENVER, CO

INDIANAPOLIS, IN

KANSAS CITY, MO

MINNEAPOLIS, MN

NASHVILLE, TN

PORTLAND, ME

ROCHESTER, NY

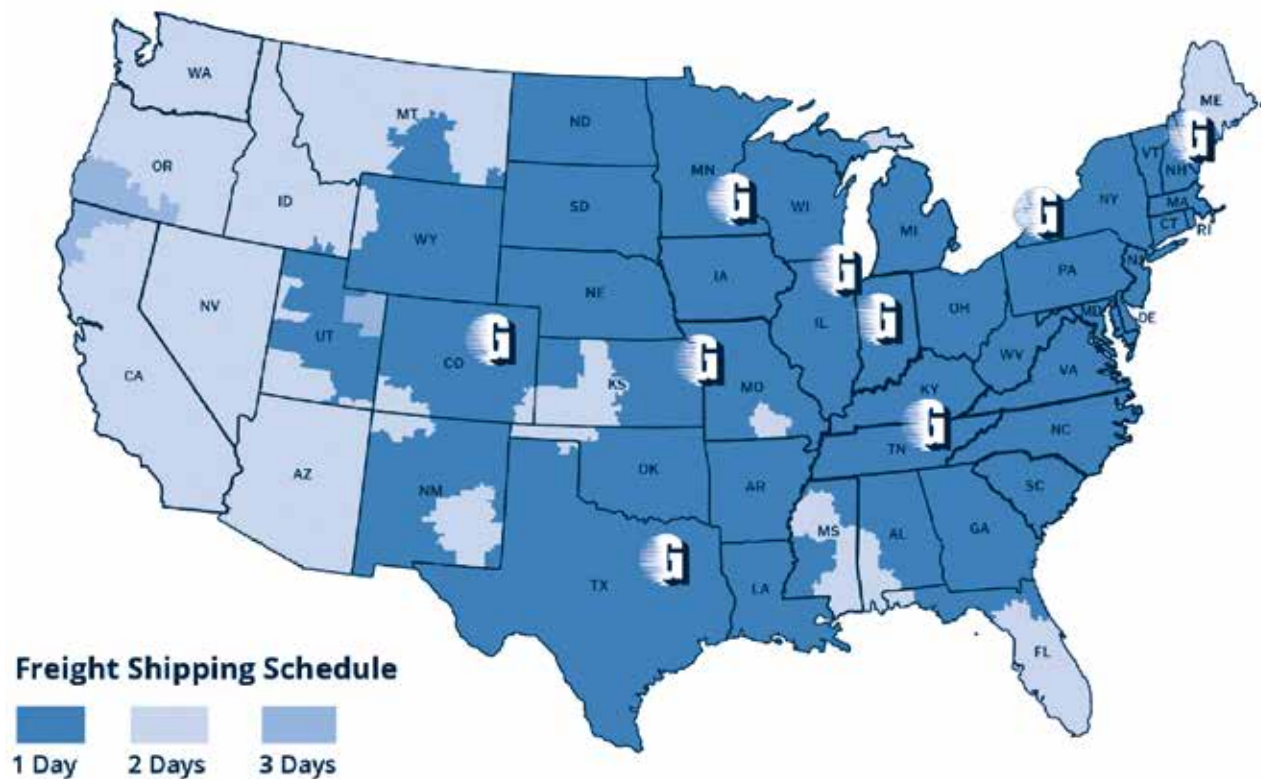

## 2,000 re-manufactured units readily available to ship today!

With an extensive inventory on-hand and ready to ship, most orders will be shipped the day of order if the order is received before 2:00 p.m. (central). Orders received after 2:00 p.m. (central) may be processed and shipped the following business day.

**NOTE:** This applies to common products. Specialty items may have longer lead times.

# Our Process

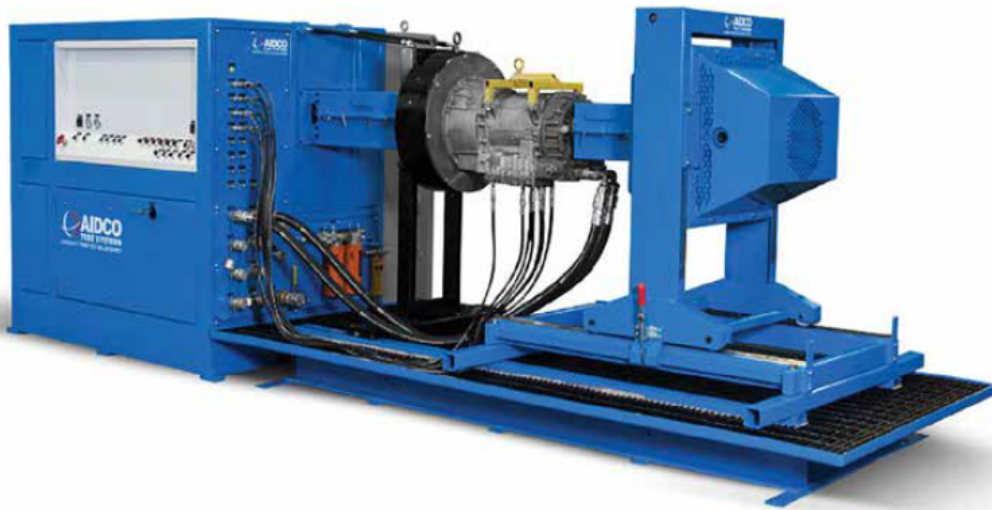

1. All transmissions and differentials are cleaned and then completely disassembled.
2. After disassembly, each unit is then cleaned again in a heated pressure-wash system and then completely dried.
3. After the secondary wash, every component is thoroughly inspected. All bearings, races, seals, friction material components (synchronizers, clutch plates, etc.) and hoses are discarded. Any castings or gearing that do not meet OEM specifications are discarded.
4. All parts are then replaced with OEM equivalent components.
5. All cases are cleaned then painted.
6. Any updates are performed on the individual unit at this time to insure that it meets the latest OEM specifications.
7. The unit is then completely reassembled and visually inspected and manually tested for proper tolerances and function.
8. All units are tagged with a model number, ratio if applicable, and a serial number.
9. After manual testing, all manual and automatic transmissions are then fully tested on a dynamometer under load and at operating temperature. A final inspection is made to ensure a high-quality appearance.
10. All applicable component protection devices and warning labels are installed, and the unit is then appropriately packaged for shipment.





## WARRANTY COVERAGE

General Truck Parts and Equipment (hereafter, "GTP") warrants all GTP's remanufactured components to be free from material defects of workmanship or parts or components from the date of installation on all orders beginning January 1st, 2020 and, on the terms, and conditions set forth below:

- On Highway manual, Allison automated manual transmissions for 36 months/unlimited mileage from date of installation.
- On Highway differentials for 36 months/unlimited mileage from date of installation.
- Off Highway transmissions, differentials, axles and transfer cases for 6 months/ unlimited mileage/hours from date of installation.
- Steering gears/pumps for 12 months/unlimited mileage from date of installation.
- Supporting documentation acceptable to GTP that includes GTP serial number or work order number must be provided at GTP's request to verify actual installation date (i.e. shop repair order, installer invoice to end user, etc.). The failure to supply such documentation at the commencement of the warranty period shall result in warranty period commencing as of the date of sale on GTP's original invoice. If GTP remanufactured components are not installed within one year of the date of sale by GTP then the warranty period shall commence as of the date of the original sale of such component part by GTP (as opposed to the date of installation of the applicable component).

In order to pursue any claim under this warranty, the original purchaser must contact GTP's warranty claims administrator @ 1-800-621-3914 and obtain approval prior to any replacement of the failed component or repairs being performed. Failure to do so may void any and all warranty consideration.

GTP reserves the right to designate where warranty services may be performed in order to be eligible for warranty consideration.

This warranty shall cover parts and labor to repair or replace, at GTP's discretion, the failed remanufactured component.

Any documentation to support a warranty claim shall be provided at GTP's request (i.e. detailed written estimate of repairs required, photos, failure analysis, etc.) prior to any repairs or replacement being approved by GTP and performed.

GTP reserves the right to have any failed component returned to GTP's designated facility for inspection prior to any repairs or replacement being performed.

This warranty shall not extend to failures or damage incurred as a result of improper installation, improper lubrication levels, abuse, misuse, improper application, introduction of contaminants, improperly installed accessories or any other attachments that may be worn or failed (i.e. yokes, drive shafts, power takeoffs, clutches, motor mounts, engine seats, external oil coolers, etc.)

In connection with any properly submitted and approved warranty claims, GTP agrees to compensate for labor, to repair or replace, any failed component at a rate not to exceed \$90.00 per hour and shall be based on the Mitchell 1 Estimates Guide to perform the repair or replacement of that specific component. Related costs such as the replacement of accessories or related components damaged as a result of any approved warranty claims shall be negotiated and approved by GTP prior to any repairs or replacement being performed. A maximum of \$500.00 may be reimbursed for any towing/recovery expense that may be incurred as a result an approved warranty claim subject to GTP's receipt of supporting documentation if requested by GTP.

All warranty reimbursement will be to the original purchaser of the remanufactured component, unless other arrangements are made and approved by GTP prior to any repairs or replacement being performed. Customers with open accounts, in good standing, with GTP will be reimbursed in a form of a credit on their account. Cash customer's will be paid by GTP check or approved transfer of funds. All approved reimbursements will be honored within 30 days of services being performed.

Any component repaired or replaced under this warranty shall retain the remainder of its original warranty period.

Notwithstanding anything herein to the contrary, GTP shall not be responsible for, nor shall GTP be deemed to have breached its obligations hereunder, due to any delay or failure in performance resulting from any cause beyond GTP's control. Such acts shall include, but are not limited to, acts of God, acts of war, riot, epidemics, fire, floods or other disaster, acts of government, strikes or lockouts, material and parts shortages, tariffs, embargos, communication line failures, power failures, failures of computer equipment or software. In the event GTP is delayed in complying with this warranty due to causes beyond its control, the delayed performance shall be performed as soon thereafter as is reasonably feasible.

EXCEPT AS REQUIRED BY LAW AND EXPRESSLY PROVIDED HEREIN, THE WARRANTIES HEREIN ARE IN LIEU OF ALL OTHER EXPRESS, IMPLIED, ORAL OR STATIONARY WARRANTIES AND LIABILITY ASSOCIATED WITH ANY PRODUCTS OR GOODS AND GTP MAKES NO OTHER WARRANTIES, EXPRESS OR IMPLIED, INCLUDING WITHOUT LIMITATION, ANY WARRANTY OF MERCHANTABILITY OR WARRANTY OF FITNESS FOR A PARTICULAR PURPOSE.  
LIMITATIONS

NOTWITHSTANDING ANYTHING CONTAINED HEREIN TO THE CONTRARY, GTP'S EXCLUSIVE OBLIGATION UNDER HEREUNDER SHALL BE, IN GTP'S SOLE DISCRETION, TO PROVIDE REPLACEMENT PRODUCTS OR REFUND THE PURCHASE PRICE OF THE DEFECTIVE OR NON-PERFORMING PRODUCT. GTP SHALL NOT BE LIABLE FOR INDIRECT DAMAGES OF ANY KIND, INCLUDING WITHOUT LIMITATION, LOST OR ANTICIPATED PROFITS, DELAY, INCIDENTAL CONSEQUENTIAL OR SPECIAL DAMAGES INCLUDING, BUT NOT LIMITED TO COSTS FOR LODGING OR FOOD EXPENSES, DOWN TIME, LOST REVENUES OR WAGES. IN NO EVENT SHALL THE AGGREGATE LIABILITY OF GTP IN RESPECT OF PRODUCT SOLD EXCEED THE PURCHASE PRICE FOR SUCH PRODUCT ACTUALLY PAID BY THE PURCHASER THEREOF AND RECEIVED BY GTP.

## CORE POLICY

### CORE RETURN POLICY

- The core should be returned on the pallet originally received with the replacement unit. Properly secure the unit to the pallet. Any damage to the core during shipping due to poor packaging will be reflected in deductions from the core credit.
- Credits for the returned cores will be issued to the original purchaser.
- Cores that are returned that have not been completely drained of oil will receive a deduction of ten (10) percent of the full core value.

### EVALUATION

Cores that are returned in an unusable condition will not be accepted or processed for credit. By not processing for credit, the customer does not lose return eligibility. However, the customer will be responsible for freight charges associated with the return of an unusable core. The following are examples of unusable conditions:

- Full of tar (i.e. synthetic and mineral oil mixture)
- Gears that are blue or burned due to lack of lubrication
- Excessive rust that causes pitting and damage
- Missing internal parts (due to physical removal, not failures)
- Cases or housings that are cracked, broken or bulging
- A disassembled core with missing parts

No core credit will be issued for cores returned in unusable condition. Customers will be charged back freight costs for cores that are submitted in an unusable condition.

GTP recommends steam cleaning the core prior to inspection for proper evaluation. A clean core will allow your inspector to identify cracks that may not have been noticeable when dirty.

### CUSTOMER RESPONSIBILITIES

1. Confirm the model of the core you are returning. Cores must be "like for like" unless prior arrangements have been made.
2. Make a thorough inspection for visible cracks, especially in the high stress areas of the cases.
3. We recommend removing the top cover/shift-bar housing on transmissions to inspect the internal components. We will remove the top cover during our inspection. To avoid the deduction for disassembly or missing parts, the top cover must be reattached to the transmission in such a manner as to avoid part damage or loss during shipping.
4. Make sure the unit is complete
5. Make sure to remove and transfer to your replacement unit, all other external equipment not supplied (i.e. yokes, shift-tower, PTOs, bell housing, etc...)
6. Please attach the core tag that was shipped with the unit and make sure that is thoroughly completed with the proper information.

You will be notified by phone if any core returned is unacceptable or if there are deductions to the full core credit based on our criteria. Any cores deemed unacceptable may be returned to you F.O.B. Chicago at your discretion.

Cores are processed daily and credits will be applied to your account within 5 business days after arrival on our dock. Cores returned without the proper core tag are subject to delays in this process.

### SOME EXAMPLES OF UNACCEPTABLE CORES



Figure 1: Rust



Figure 2: Gelled Lube



Figure 3: Cracked Case



## RETURN POLICY

Order cancellations: You may cancel an order at any time prior to shipment, free of charge.

If you cancel an order after it ships or refuse delivery (except for deliveries refused due to shipping damage), it will be treated as a return and may be subject to shipping charges and restocking fees.

Return Policy: If you are not completely satisfied with your purchase, items can be returned within 30 days of date on invoice.

Most commonly stocked items are easily returnable. Some exclusions, restrictions or charges may apply.

All approved returned merchandise must be in unused and resalable condition.

The returned merchandise must be returned in its complete state, including hardware, instructions, labeling, etc. Product that has been installed or damaged in any way is no longer in unused and resalable condition and may be subject to a restocking fee.

Each of our manufactured components is covered by an expressed warranty against defects and workmanship errors. Warranty returns are subject to the terms and conditions stated in our warranty policy. Please contact Curt Ladendorf at 1-800-621-3914 and he will assist in processing your claim.

All returned items require a Returned Goods Authorization number/form.

Returned Goods Authorization (RGA) Procedure: Before returning any item, please call 1-800-621-3914 or e-mail [returns@generaltruckparts.com](mailto:returns@generaltruckparts.com) to discuss your return and receive an RGA (Returned Goods Authorization) number. Please have the original invoice and all appropriate contact info available, along with the reasoning for your return. No returns will be accepted without obtaining an RGA number. The RGA number and any applicable paperwork must accompany any Returned Goods.

Items returned without prior authorization will not be accepted and may be refunded to you at your expense.

Shipping procedures/ expenses for warranty returns and shipping error on our part will be coordinated at the time of return approval.

Additional Terms and Conditions: We do not reimburse for any installation, removal, labor, towing or other incidental charges unless a proper warranty/ return claim has been arranged and agreed upon prior to the return.

All product returns will be credited/refunded within 7-14 business days after receipt and inspection of returned goods.

All credits will be applied to the open account or the credit card number that the returned goods were originally purchased against. Cash or check (C.O.D.) purchases will be reimbursed by a company check and mailed directly to the address supplied at the time of original purchase.

A 15% restocking fee may apply to all returns that are not due to error on our part or warranty returns or do not adhere to the above return policy.

The customer will be responsible for all freight charges for product returned other than warranty defect or shipping error on our part. Any freight charges incurred on our end may be charged back to you unless prior arrangements have been made. The customer will be charged freight for replacement product due to customer order error, any "free" freight agreement/promotions will not apply.

Exchange of Product: Items being returned in exchange for another are subject to the same terms and conditions as returned items.

If the item you are exchanging for is priced differently than the item you are returning, your payment will be refunded or charged the price difference, including any applicable shipping and restocking fees.

If you need a replacement item quickly, rather than waiting for the returned item to be received and inspected you may place a new order for the item needed. Your payment for the returned item will then be refunded within 7-14 business days after receipt and inspection (less any applicable shipping and restocking fees).

The customer is responsible for all return shipping charges and applicable restocking fees.

Orders Damaged in Shipping: If your product arrives with obvious, noticeable damage, refuse the shipment and notify us immediately at 1-800-621-3914 or e-mail us at [returns@generaltruckparts.com](mailto:returns@generaltruckparts.com). Please document reason for refusal on any paperwork/shipping receipt that the carrier may have. Failure to document reason for refusal on the carrier document may result in their refusal to any claim.

Concealed Damage: If your shipment arrives intact, but when opening the package you find the item is damaged, please contact us at 1-800-621-3914 and speak with your customer service representative immediately. Concealed damage must be reported within 2 business days of delivery. Please keep all packaging, pallets, etc. for possible claims requirements. Photos of damage, packaging may be useful in speeding up the claims process. Failure to report such damage within 2 business days of receipt may void any claims opportunity.

If you have any questions regarding any of this policy, please contact us at 1-800-621-3914 and speak with one of our customer service representatives.

**\*\*\*\* Special order items and electrical items are non-refundable \*\*\*\***

## Platform "G"

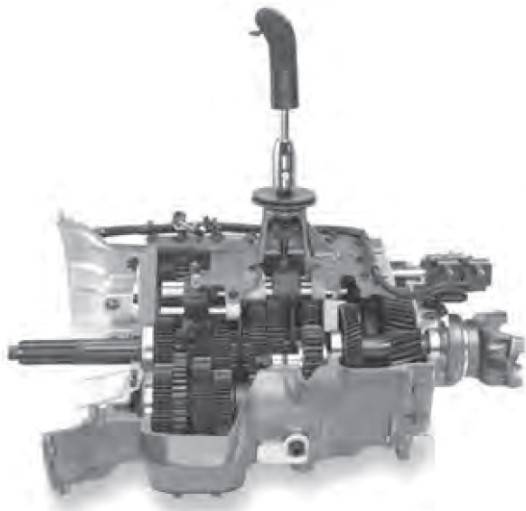

PLATFORM "G" MANUAL



PLATFORM "G" SURESHIFT

### Identification

An identification plate is installed on the right side of the platform "G" transmissions.

### Model Nomenclature

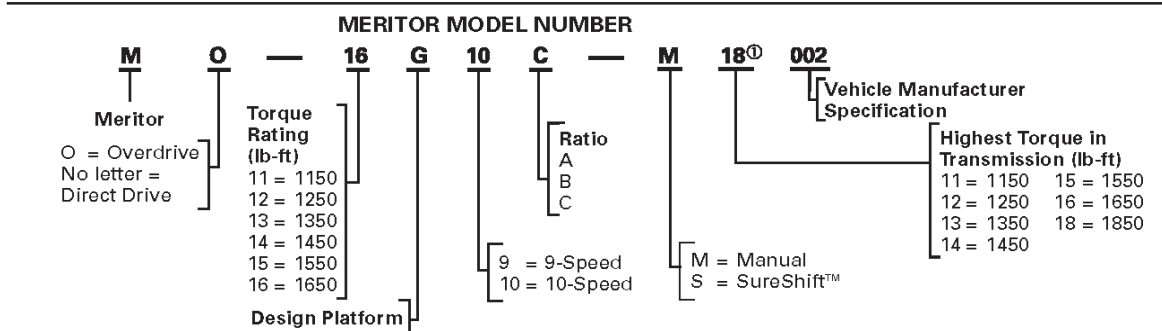
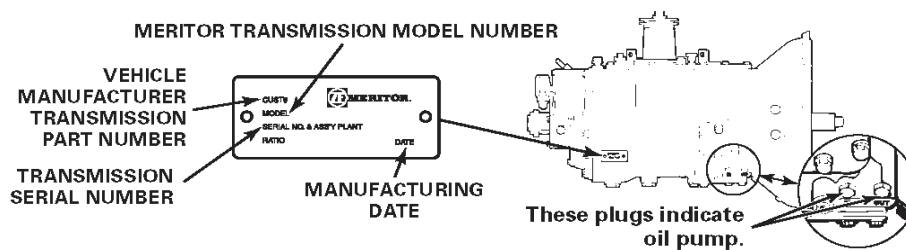

- ① Progressive torque is an engine feature that requires a Torq-2 transmission. In models not featuring progressive torque, this number will be the same as the torque rating.
- ② Detroit Diesel Corporation

## Nomenclature - Automated

### New Nomenclature System Components

- Prefix
  - F for Fuller®: All medium-duty and heavy-duty UltraShift® products in North America and Australia
  - E for Eaton: All other products (including UltraShift outside North America and Australia)
  - Parenthetical letters such as (O) and (M) indicate provisions for Overdrive, Multi-Torque and other configurations
- Model Designator
  - Nominal Torque Capacity (lb/ft for North America and Australia)
  - Configuration: alpha designator A,B,C,D... for launch device and other system components
  - Design Level: numeric designator describes mechanical and electronic design levels
  - Gear Ratio Set: alpha designator (unchanged)
  - 3-Letter Suffix: denotes application and value

### Heavy-Duty UltraShift Example

Example: Fuller UltraShift Linehaul Efficient Performance (LEP)

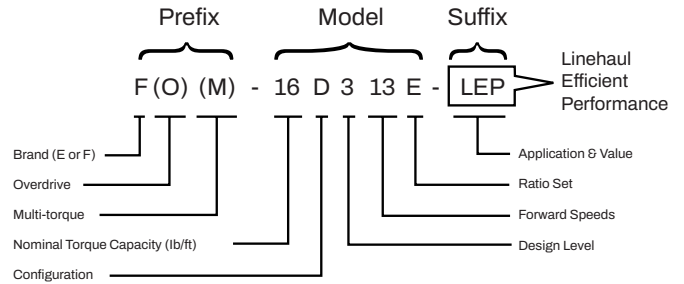

### Medium-Duty UltraShift Example

Example: Fuller UltraShift XX (for future use as new products and significant upgrades are introduced)

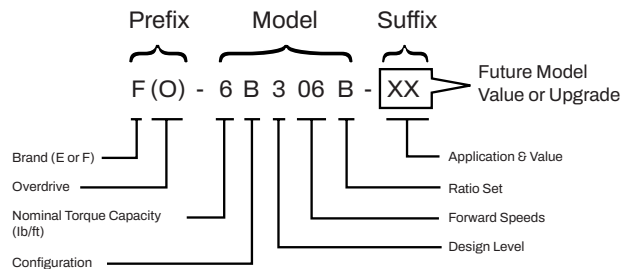

### Heavy-Duty Automated Example

#### Heavy-Duty Automated Example

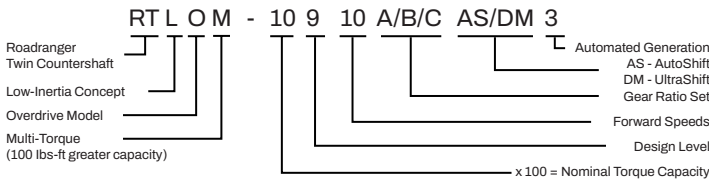

Note: Eaton and Spicer mid-range models would require a T/A (Transmission Assembly) number or B/M (Bill of Material) number for proper identification. If these numbers can't be found, we will need certain info such as input shaft numbers, input retainer numbers, rear bearing retainer numbers and case casting numbers.

### Hybrid Power System Example

Example: Eaton Hybrid City Delivery (CD)

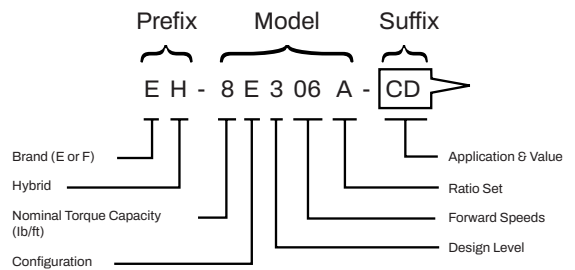

## Nomenclature - Manual

### Heavy-Duty Example

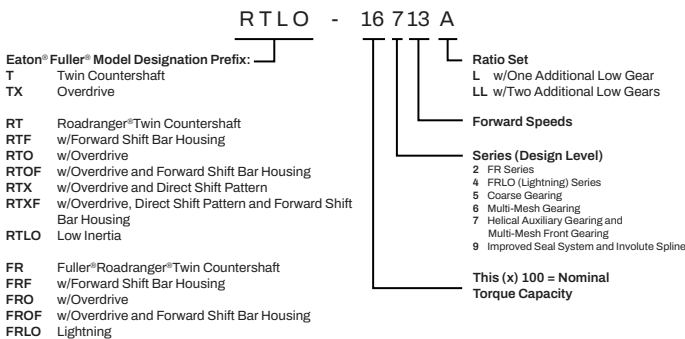

### Medium-Duty Example

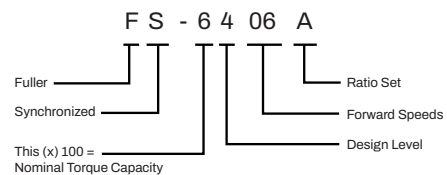

## Ring Gear & Pinion Identification

- Ring Gear and Drive Pinion are matched parts and must be replaced in sets.
- Complete Identification is stamped on both parts as shown on the drawing below.

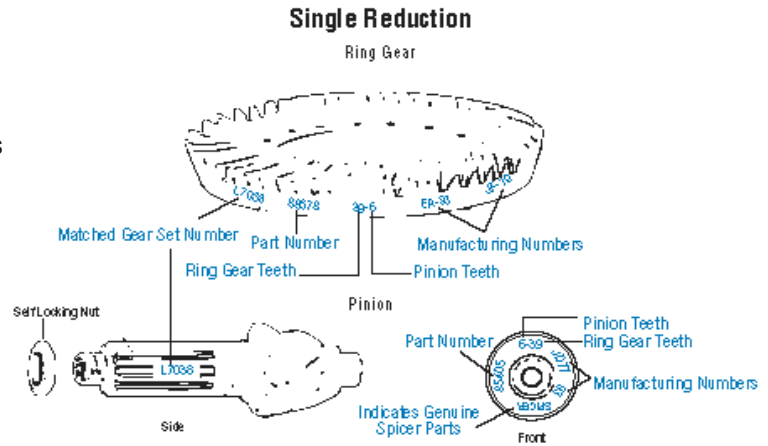

## Yokes

### Input or Output Yokes

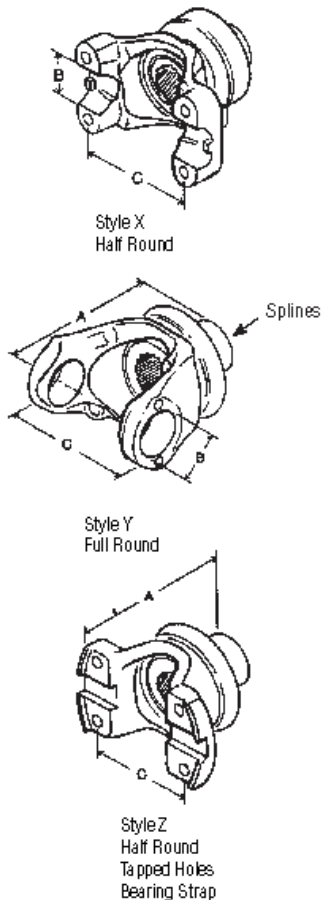

## Single, Tandem and Tridem Rear Drive Axles

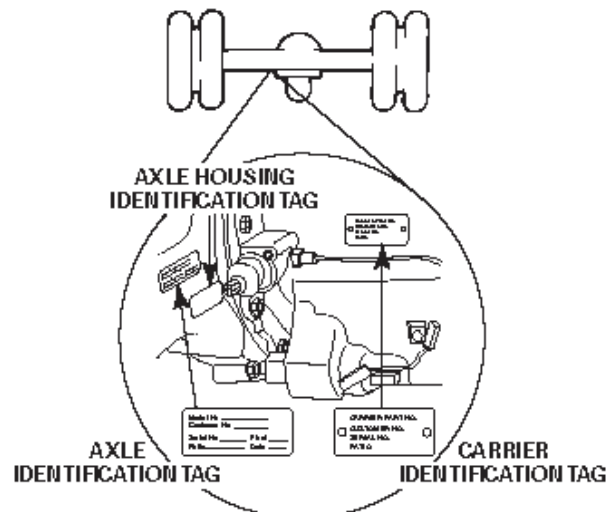

### AXLE IDENTIFICATION TAG INFORMATION

Model No. ....	.....
Customer No. ....	.....
Serial No. ....	Plant .....
Ratio .....	

IDENTIFICATION TAG

LOCATION OF THE IDENTIFICATION TAG, OR STAMP NUMBER, FOR THE AXLES. LOCATION IS DETERMINED FROM THE LEFT DRIVER SIDE LOOKING TOWARD THE FRONT OF THE VEHICLE.

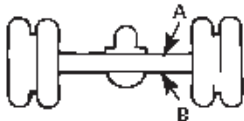

- A – FRONT ENGINE DRIVE – RIGHT REAR, NEXT TO COVER
- B – REAR ENGINE DRIVE – LEFT OR RIGHT REAR, NEXT TO DRIVE UNIT

Note: When identifying differentials, if no tag can be found, we may need a number off the ring gear or pinion gear, axle spline counts, input spline counts and output spline counts, depending on the model.

### AXLE HOUSING SHAFT



## Model Identification

### Locating model Designation Information

- Axle Model Identification, Part Number and Serial Number are located on a tag at the axle centerline.

## Drive Axles

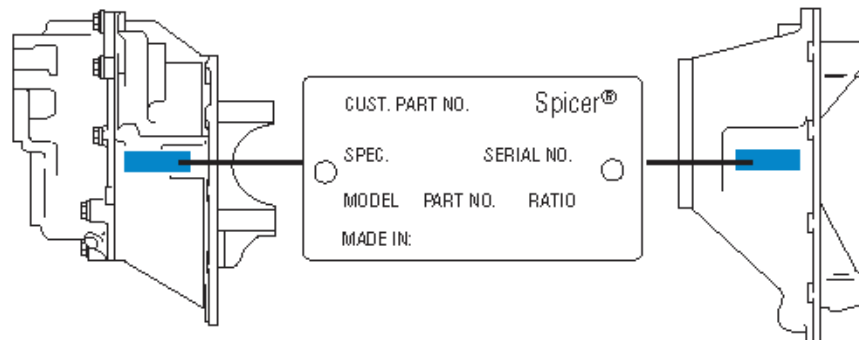

- **Model Number, Part Number and Serial Number** are located on the data plate on the axle centerline

## Drive Axle Assembly Tag

1. The OEM part number assigned to the axle build.
2. The specification number assigned to the axle build by Spicer. The spec number will identify all the component parts of the axle as built by Spicer, including special OEM requirements such as yokes or flanges.
3. The axle model identification.
4. The production or service part number of the carrier assembly.
5. The gear ratio of the axle.
6. The serial number of the carrier assembly assigned by the manufacturing plant.
7. Country of Origin

The logo features a large, stylized letter 'G' on the left, composed of horizontal lines that create a sense of motion or speed. To the right of the 'G', the word 'GENERAL' is written in a bold, blue, sans-serif font. Below 'GENERAL', the words 'TRUCK PARTS' and '& EQUIPMENT' are stacked in a smaller, white, sans-serif font.

**GENERAL**  
**TRUCK PARTS**  
**& EQUIPMENT**

**MAKE ONE CALL. WE STOCK IT ALL!**

**800-621-3914**

[www.generaltruckparts.com](http://www.generaltruckparts.com)

**CORPORATE HEADQUARTERS**

4040 W. 40th Street, Chicago, IL 60632

[info@generaltruckparts.com](mailto:info@generaltruckparts.com)